

OUTLINE DIMENSIONAL DRAWING

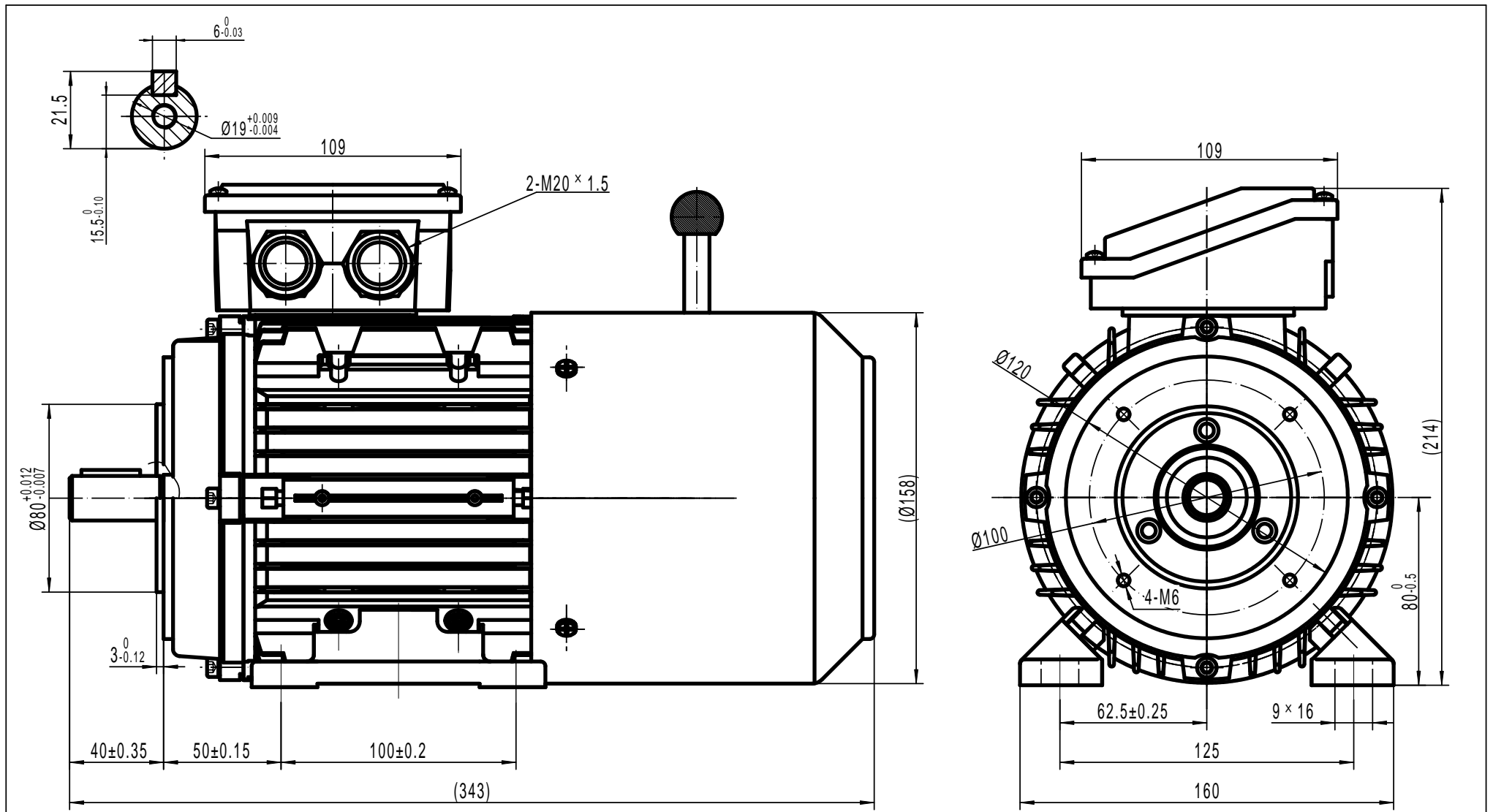

TECHTOP
AUSTRALIA

TECHTOP AUSTRALIA PTY LTD	
FRAME	TAIB 80A B34
DATE	DRAWING NO.
2013/10/22	1ST102.052.001-020 A